



SUBMITTAL DATA - INDOOR UNIT
VE1C012N432U
VRF 1-WAY CASSETTE TYPE EVAPORATOR

Job Name: _____
Location: _____
Schedule No.: _____
System Designation: _____

Engineer: _____
Architect: _____
Date: _____
For: ___ Reference ___ Approval ___ Review ___ Construction

FEATURES

- Auto Addressing installation
- Auto Restart
- Integrated Condensate Pump
- Built-in Electronic Expansion Valve
- LED Display
- Washable Filter
- Anti-Freezing Protection

PRODUCT WARRANTY

All covered components - Five year limited warranty

SPECIFICATIONS

PERFORMANCE

Cooling Capacity* (Btu/h)		12,283
Heating Capacity* (Btu/h)		13,648
Airflow (CFM)	High	355
	Medium	295
	Low	265

Sound Pressure Level (dBA) H / M / L 36/32/28

ELECTRICAL DATA

Power Supply (V / Hz / Ph)	220-240/50/1 - 208-230/60/1
MOP (A)	6
Rated Current (A)	Cooling 0.2
	Heating 0.2

DIMENSIONS

Unit Dimensions (in)	Height	7
	Width	39
	Depth	15 1/4

Liquid Pipe Connection (in)	1/4
Gas Pipe Connection (in)	1/2
Shipping Weight (lb)	60
Net Weight (lb)	44

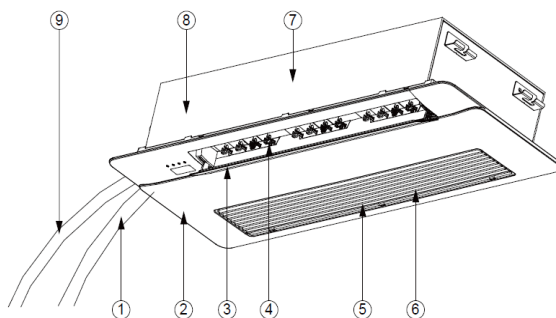

1. Pipe Connection
2. Front Panel
3. Air Louver
4. Swing Louvers
5. Air Grill
6. Air Filter
7. Main Body
8. Built-in Condensate Pump
9. Drain Pipe

NOTES:

*Cooling and Heating Capacity data is rated at the following conditions:

Cooling: 80 °F DB / 67 °F WB Indoor, 95 °F DB Outdoor

Heating: 70 °F DB Indoor, 47 °F DB

NOTE – Due to Lennox' ongoing commitment to quality, Specifications, Ratings and Dimensions subject to change without notice and without incurring liability. Improper installation, adjustment, alteration, service or maintenance can cause property damage or personal injury. Installation and service must be performed by a qualified installer and servicing agency. ©2020 Lennox Industries Inc.



SUBMITTAL DATA - INDOOR UNIT
VE1C012N432U
VRF 1-WAY CASSETTE TYPE EVAPORATOR

DIMENSIONAL DRAWINGS

TOP VIEW

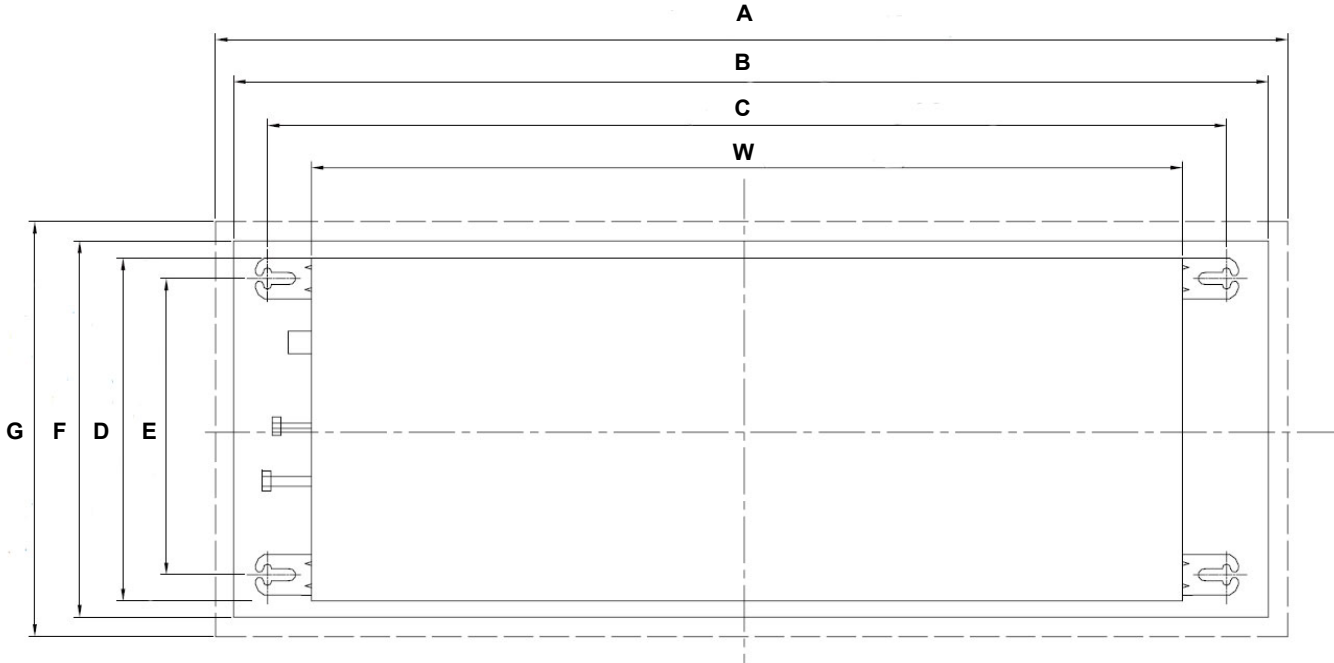

Side	mm	in	Description
A	1200	47 1/4	Front Panel Width
B	1115	44	Ceiling Outlet Width
C	1027	40 1/2	Holding Brackets Width
W	987	39	Width
E	261	10 1/4	Holding Brackets Depth
D	385	15 1/4	Depth
F	415	16 1/4	Ceiling Outlet Depth
G	456	18	Front Panel Depth

NOTE – Due to Lennox' ongoing commitment to quality, Specifications, Ratings and Dimensions subject to change without notice and without incurring liability. Improper installation, adjustment, alteration, service or maintenance can cause property damage or personal injury. Installation and service must be performed by a qualified installer and servicing agency. ©2020 Lennox Industries Inc.